

# Perfis Esponjosos

Legenda: \* Policloroprene (Neoprene) | \*\* EPDM | \*\*\*Nitrílica

Fone Fax: (47)3027 2345 E-mail: vendas@lbborrachas.com.br Acesse: www.lbborrachas.com.br

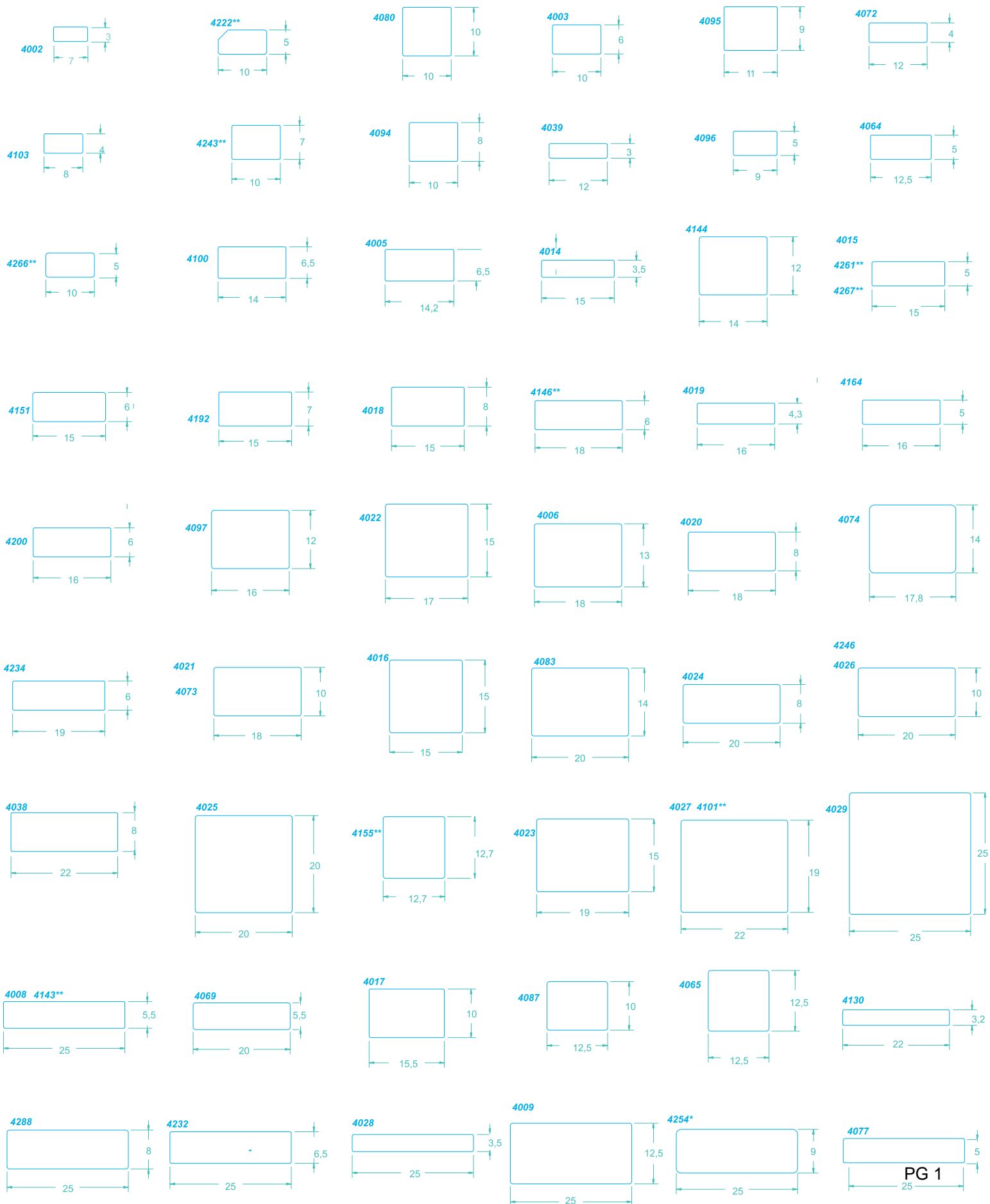

# Perfis Esponjosos

Legenda: \* Policloroprene (Neoprene) | \*\* EPDM | \*\*\*Nitrílica

Fone Fax: (47)3027 2345 E-mail: vendas@lbborrachas.com.br Acesse: www.lbborrachas.com.br

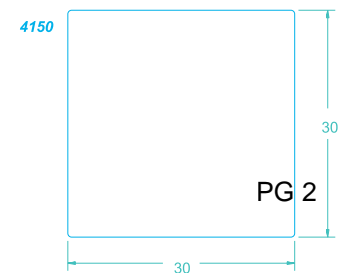
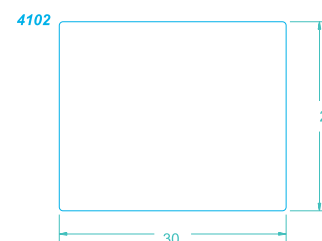
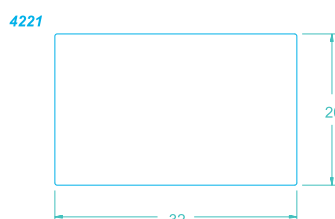
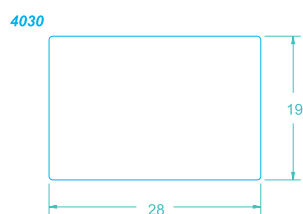
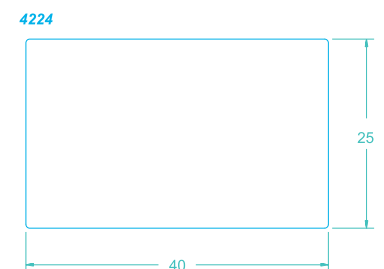
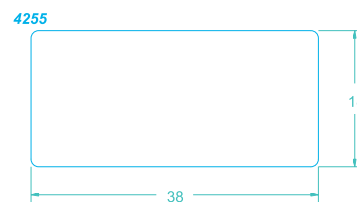
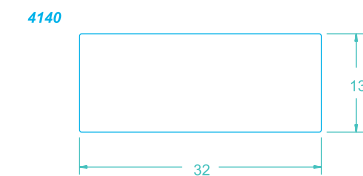
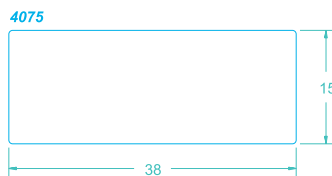
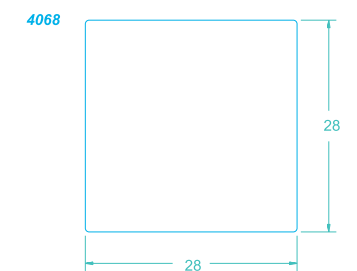
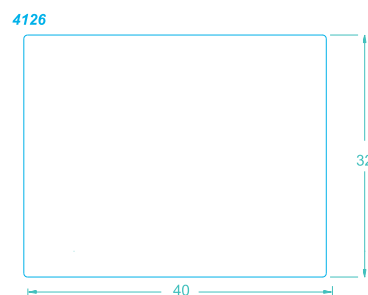
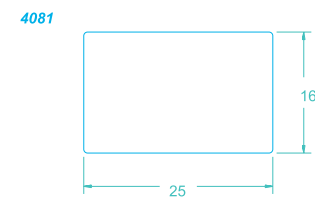
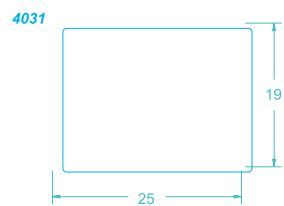
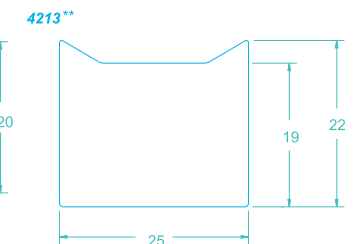
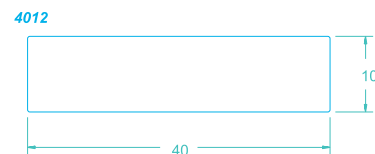
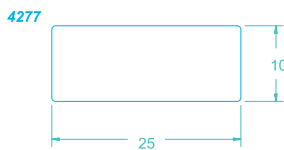
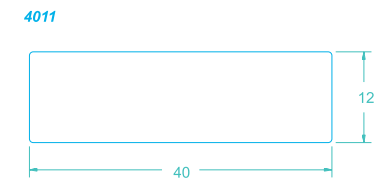
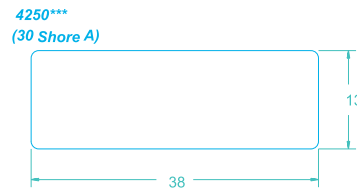
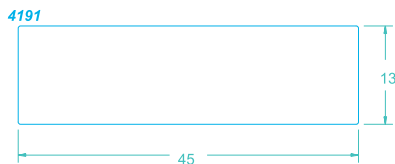
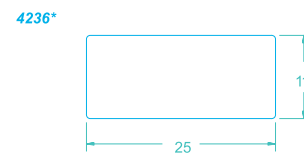
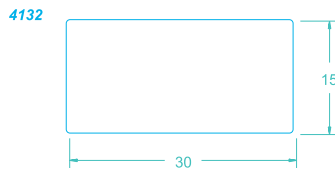
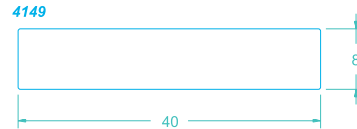
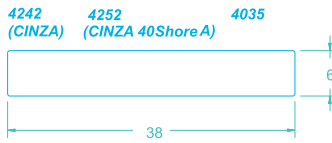
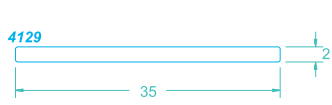

# Perfis Esponjosos

Legenda: \* Policloroprene (Neoprene) | \*\* EPDM | \*\*\*Nitrílica

Fone Fax: (47)3027 2345 E-mail: vendas@lborrachas.com.br Acesse: www.lborrachas.com.br

4259

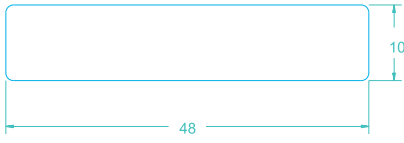

4176

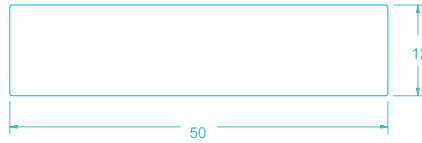

4196

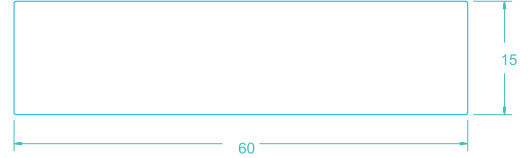

4040

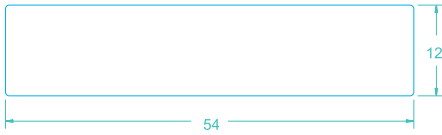

4037 4076\*\*

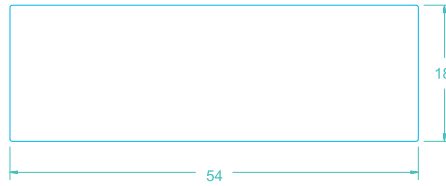

4214

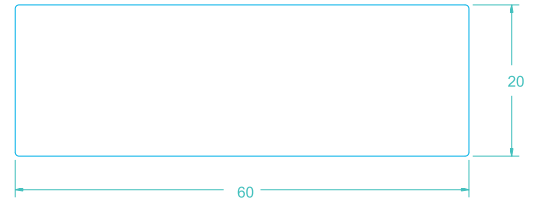

4152

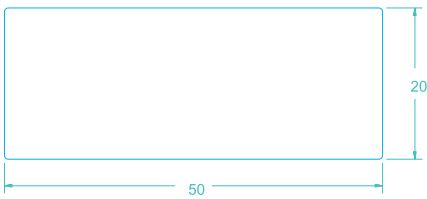

4089 4082\*\*

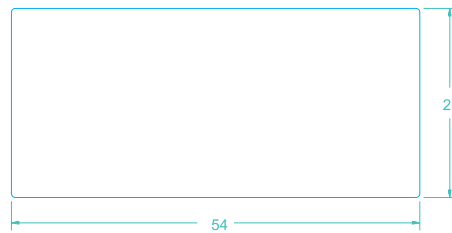

4135 4209  
(15 Shore A)

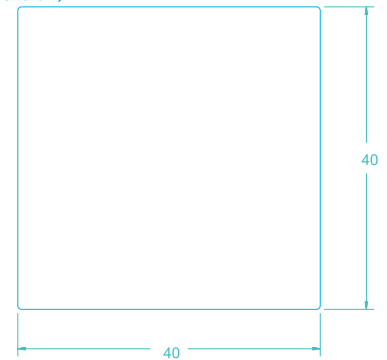

4118

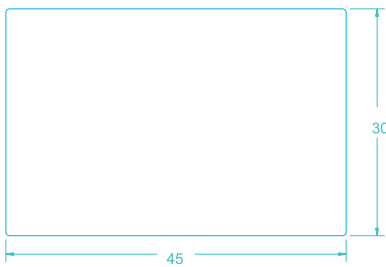

4181

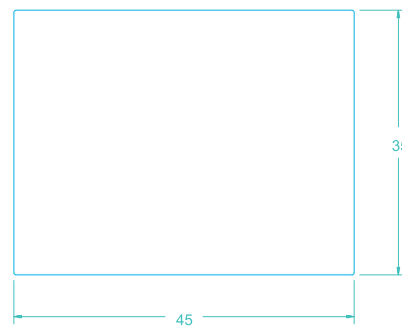

4119  
(15 Shore A)

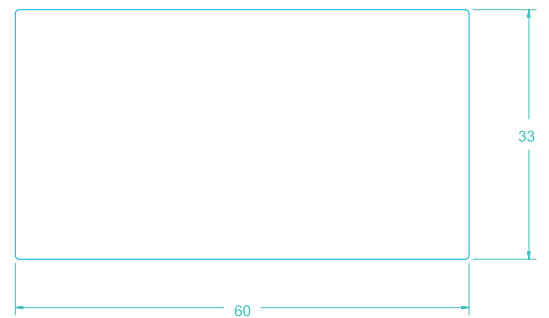

4001

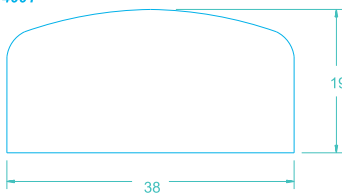

4098

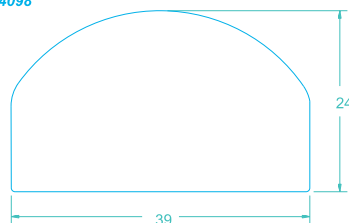

4182

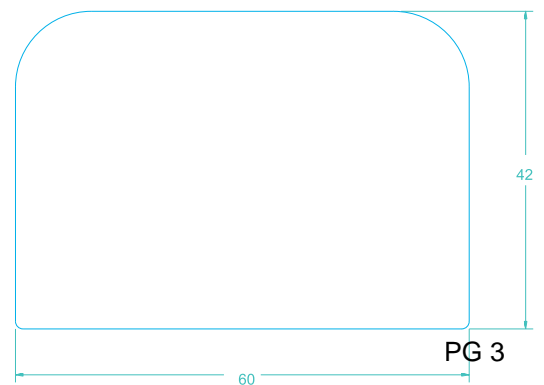

# Perfis Esponjosos

Legenda: \* Policloroprene (Neoprene) | \*\* EPDM | \*\*\*Nitrílica

Fone Fax: (47)3027 2345 E-mail: vendas@lbborrachas.com.br Acesse: www.lbborrachas.com.br

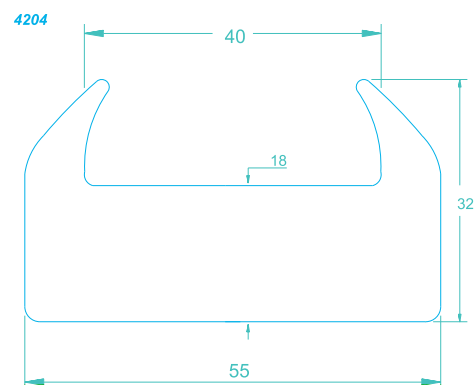
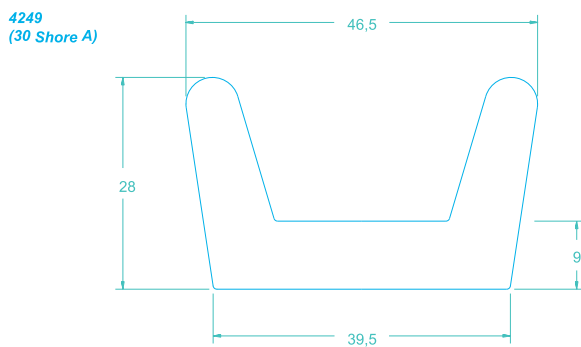
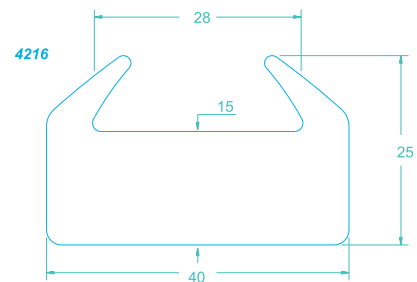
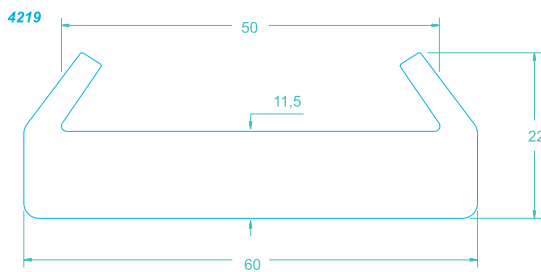
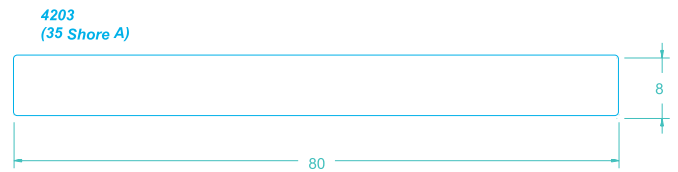
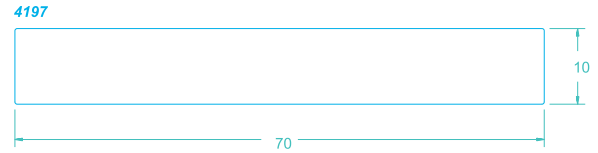
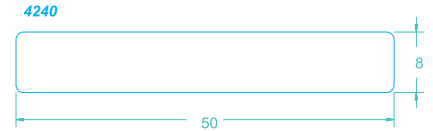
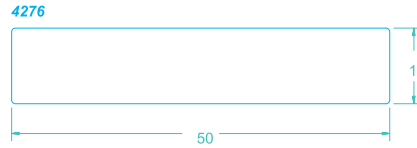
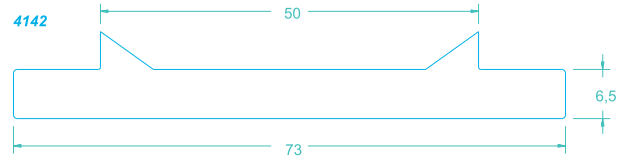
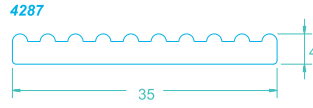
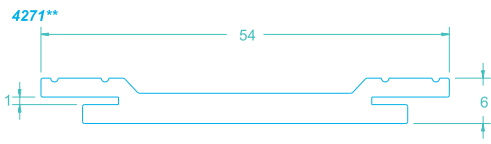

# Perfis Esponjosos

Legenda: \* Policloroprene (Neoprene) | \*\* EPDM | \*\*\*Nitrílica

Fone Fax: (47)3027 2345 E-mail: vendas@lbborrachas.com.br Acesse: www.lbborrachas.com.br

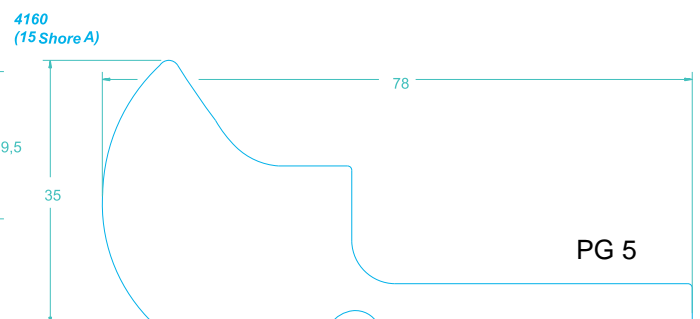
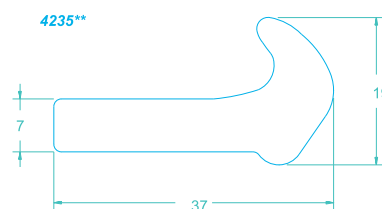
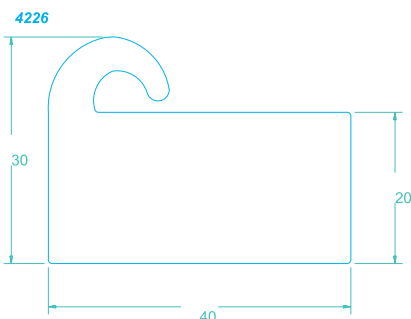
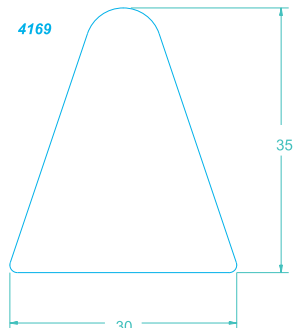
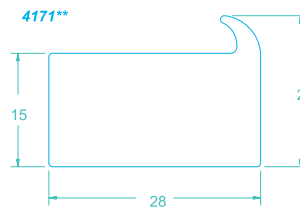
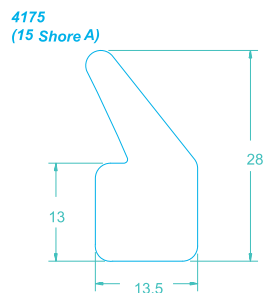
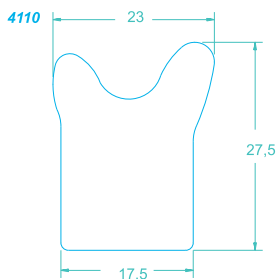
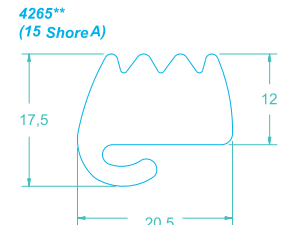
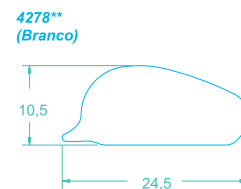
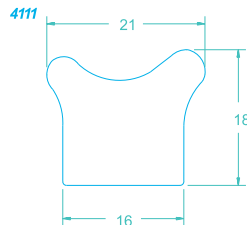
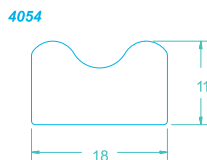
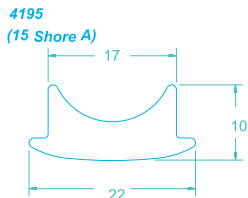
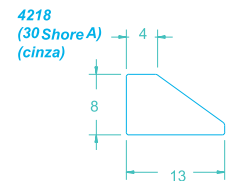
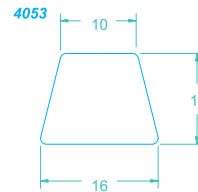
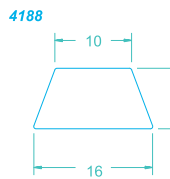
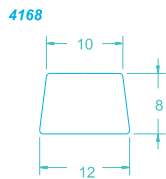
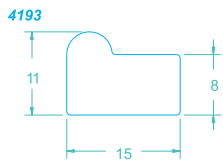
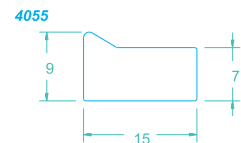
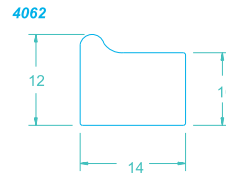
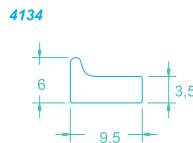
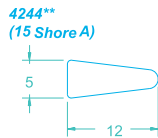
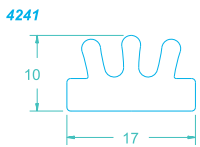
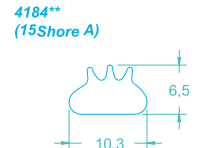
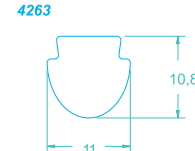
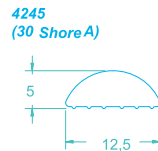
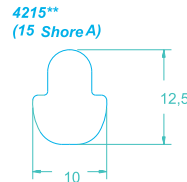
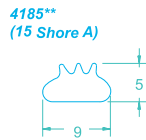
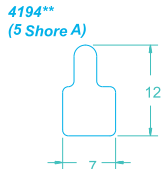
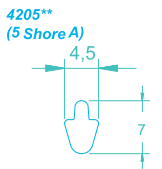
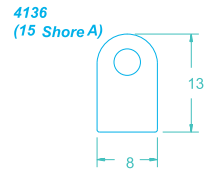
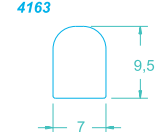
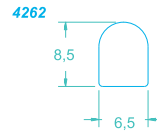
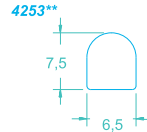
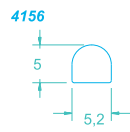
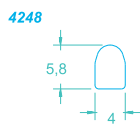
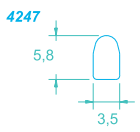

# Perfis Esponjosos

Legenda: \* Policloroprene (Neoprene) | \*\* EPDM | \*\*\*Nitrílica

Fone Fax: (47)3027 2345 E-mail: vendas@lbborrachas.com.br Acesso: www.lbborrachas.com.br

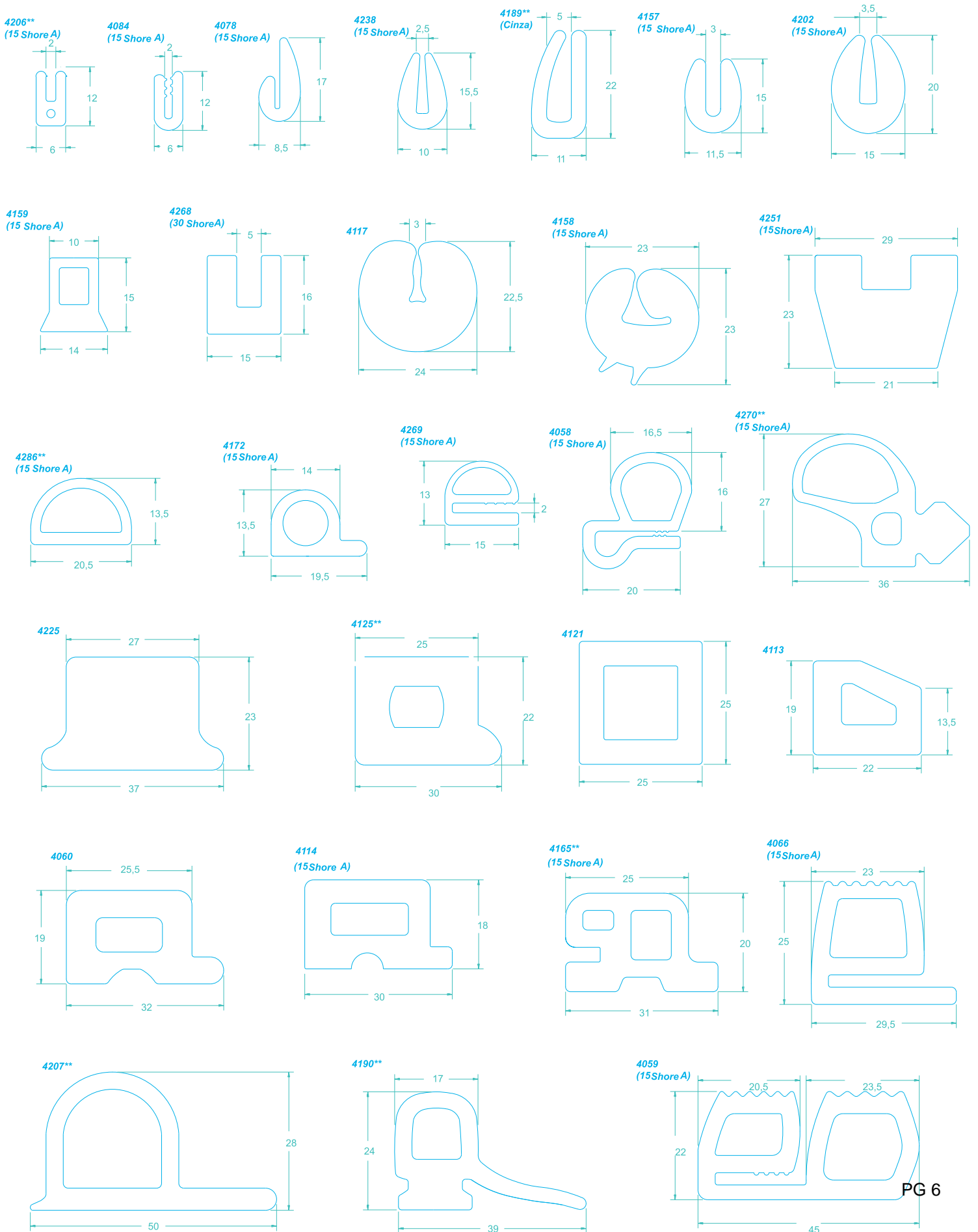

# Perfis Esponjosos

Legenda: \* Policloroprene (Neoprene) | \*\* EPDM | \*\*\*Nitrílica

Fone Fax: (47)3027 2345 E-mail: vendas@lbborrachas.com.br Acesse: www.lbborrachas.com.br

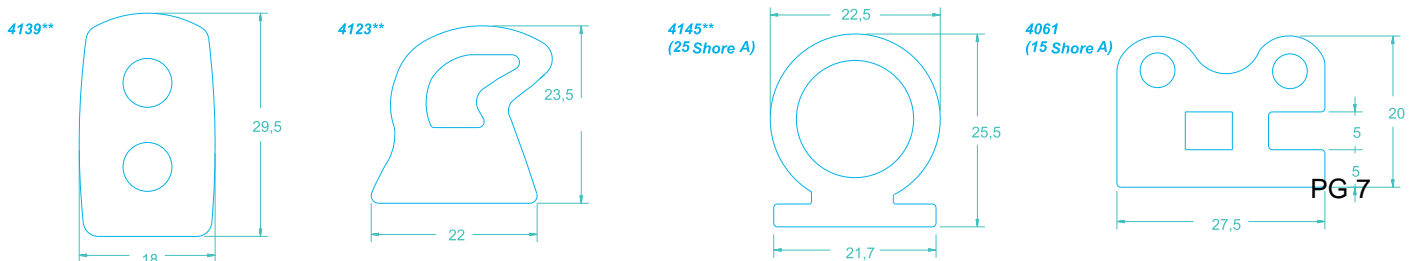
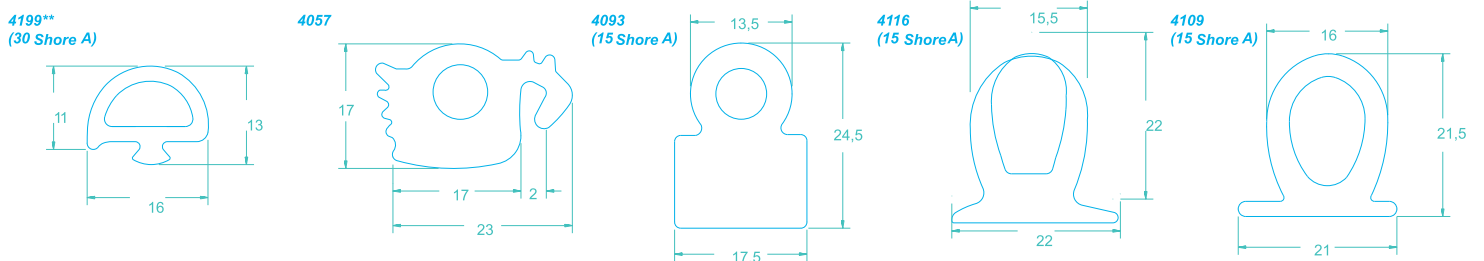
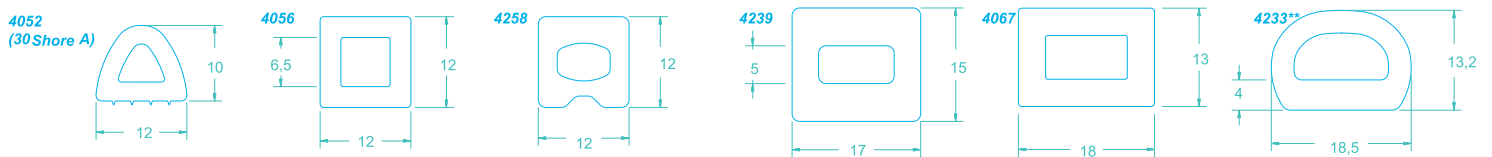
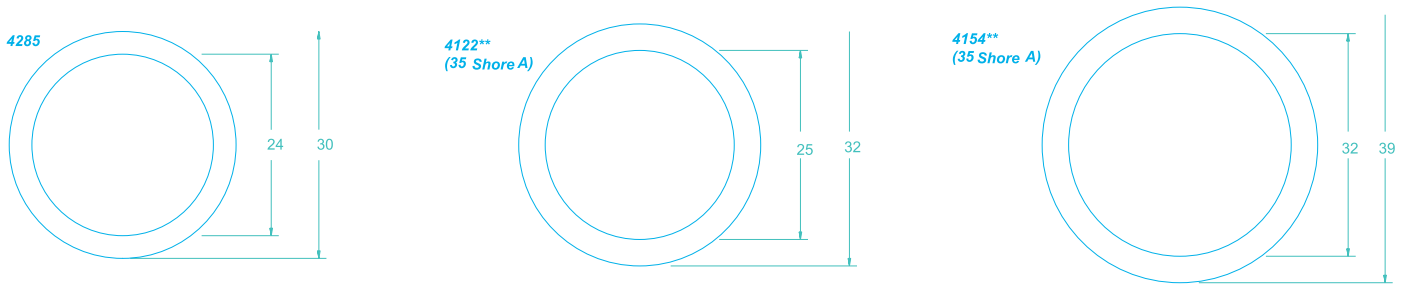
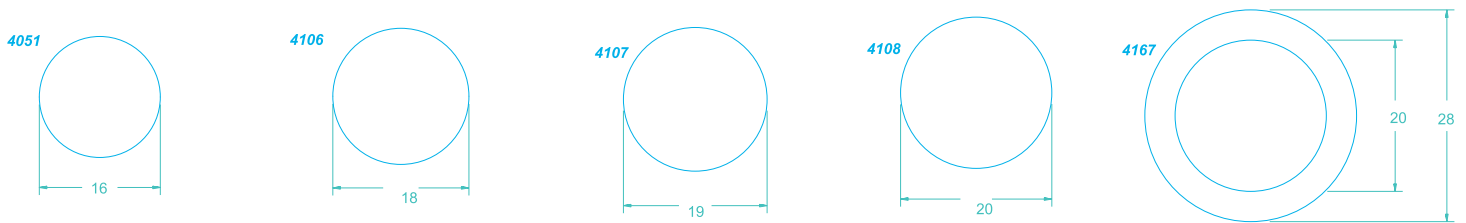
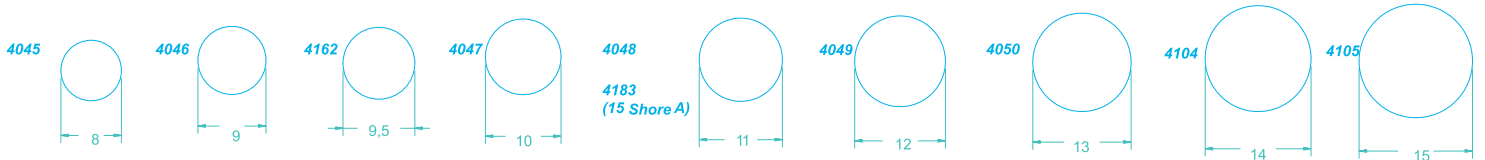
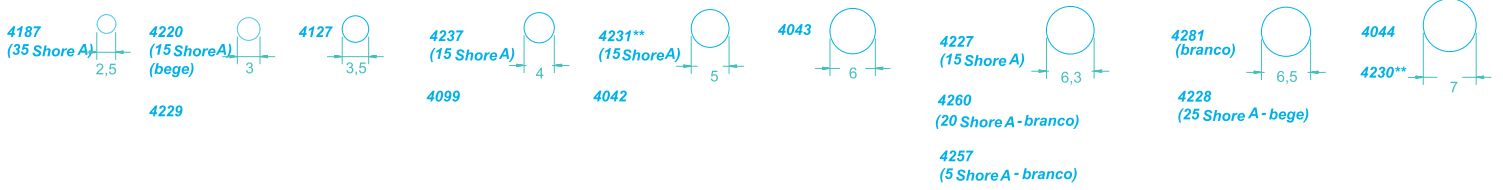

# Perfis Esponjosos

Legenda: \* Policloroprene (Neoprene) | \*\* EPDM | \*\*\*Nitrílica

Fone Fax: (47)3027 2345 E-mail: vendas@lbborrachas.com.br Acesse: www.lbborrachas.com.br

